

Wand-/Deckenluftkühler

Unit coolers



6



GÜNTNER *incline design*
3°



schwenkbare Seitenverkleidung

hinged side covering

GGHN.2

50 Hz

Sole / Brine

- Verbesserter Tauwasserrücklauf und verbesserte Luftführung durch Güntner Incline Design
- Gute Zugänglichkeit: aufklappbare Seitenverkleidung + optional schwenkbare Ventilatoren
- Hohe Wurfweiten durch optionale Güntner Streamer
 - Kondenswasserfreie Wannenkonstruktion
 - 2 Ventilatorausführungen

- Improved condensation water drain and routing of air flow with Güntner Incline Design
- Good accessibility: hinged side covering + optional: swiveling fans
- Improved air throw with optional Güntner Streamer
 - Condensation-water-free drip tray
 - 2 types of fans available

www.guentner.de

Anwendungsvorteile für Betreiber

Application benefits for operators



Güntner Incline Design

- Bessere Luftführung
- Besserer Tauwasserrücklauf

Güntner Incline Design

- Better routing of air flow
- Improved condensation water drain

Kondenswasser-freie Wannenkonstruktion

Die thermisch entkoppelte Tropfwanne reduziert Kondenswasserbildung an der Außenseite.

Condensation-water-free drip tray construction

The drip tray prevents formation of condensation water at the outside due to its thermal properties.

Zeitsparende Reinigung

Hygienevorschriften verlangen eine gründliche Reinigung des gesamten Luftkühlers. Durch schwenkbare Ventilatoren (optional) können – mit einfachen Handgriffen – Öffnungen zum Reinigen des Wärmeaustauscherblockes und Innenraums geschaffen werden.

Timesaving cleaning

Hygiene regulations require thorough cleaning of the entire air cooler coil. The swiveling fans (optional) make it possible to create without much ado openings for the cleaning of the heat exchanger coil and of the unit's interior.

Abtauflappe

- Sichere und vollständige Abtauung
- Die Abtauwärme bleibt im inneren des Gehäuses

Defrost flap

- Safe and complete defrosting
- The defrosting heat remains in the evaporator casing

Nomenklatur / Nomenclature

Wand-/Deckenluftkühler Unit coolers	GGHN		
Ventilator Fan	Ø 710 mm	071	
Generation Generation		.2	
Blockgröße Coil size		F /	
Anzahl der Ventilatoren Number of fans		2	
Lamellenteilung Fin spacing		7	
Luftabtauung oder keine Abtauung Air defrost or non defrosting			- A
E-Abtauung auf Wunsch Electrical defrosting on request			- E
Ventilatoren normale Ausführung fans standard design			- N
Ventilatoren verstärkte Ausführung fans reinforced design			- H
Spannung / Phase / Frequenz Voltage / Phase / Frequency	400 V 3~ 50 Hz Δ		D W S
	230 V 1~ 50 Hz		
	400 V 3~ 50 Hz Y		

Anwendungsvorteile für Anlagenbauer und Planer

Application benefits for contractors and planners



Montage / Service / Messung **Aufklappen - Loslegen**

Die Anschlüsse sind einfach durch die aufklappbaren Seitenwände erreichbar. Noch leichter zu öffnen mit den Schnappverschlüssen für die Baugrößen 071 und 080.

Ventilator

- Bewährte Qualitätsventilatoren
- Hohe Wurfweiten durch optionale Güntner-Streamer
- Hohe Luftmenge
- Guter Wirkungsgrad
- 2 Ventilatorausführungen
 - normal
 - verstärkt

... keep(s) your quality

- Zuverlässiger Betrieb durch ausgereiftes und bewährtes Produkt
- Ansprechendes Design
- Kein Kondensatauswurf durch optimierte Luftgeschwindigkeiten in der Grundversion
- Optional verstärkte Ventilatoren für erhöhte Luftumwälzung
- Realisierung von kundenspezifischen Lösungen außerhalb des Standards möglich

Assembly/Maintenance/Gauging **Open and get started**

The connections are easily accessible through the hinged side coverings. Even easier to open with the snaplocks which are available for sizes 071 and 080.

Fan

- Reliable high-quality fans
- Extended air throw due to optional Güntner Streamer
- Large air quantity
- High efficiency
- 2 types of fans available
 - standard
 - reinforced

... keep(s) your quality

- Reliable operation of a tried and tested unit
- Pleasing design
- No spouting of condensation water due to optimised air velocities in the basic version
- Optional: more powerful fans for increased air circulation
- It is possible to realise customised solutions beyond the standard

GGHN - 1 Ventilator - 1 Fan

Typ Type	$t_i = -3\text{ °C}; dp = 0.8\text{ bar};$ Glykol 25%; $t_{i,1} = 10\text{ °C}$ bei 85% r. F. glycol 25%; $t_{i,1} = 10\text{ °C}$ at 85% relative humidity			Fläche Surface	Luftvolumenstrom Air volume flow	Wurfweite ohne Streamer Air throw without Streamer	Wurfweite mit Streamer Air throw with Streamer	Schalldruck Sound pressure	Anschlüsse Connections		El. Abtauheizung El. defrost			Anschlussschema Connection diagram	P_{el} total	Anschlussklemmen optionale Ventilatorverkabelung connection terminals optional fan wiring
	Leistung Capacity	Volumenstrom Volume flow rate	Soleaustritt Brine outlet						Ein Inlet	Aus Outlet	Block Coil	Tropfwanne Drip tray	Gesamt Total			
	kW	m ³ /h	°C	m ²	m ³ /h	m	m	dB(A)/3m	mm Ø	mm Ø	W	W	kW	1 × A	kW	1 × E
040.2D/14-ANW50	8,6	2,2	0,5	32,7	3060	11	24	52	28,0	28,0	1620	700	2,32	1 × A	0,22	1 × E
040.2F/14-ANW50	11,5	3,3	0,1	49,0	2810	10	23	52	35,0	35,0	2700	1000	3,70	1 × B	0,22	1 × E
045.2D/14-ANW50	11,5	1,8	2,8	51,3	5110	15	33	56	28,0	28,0	2580	1200	3,78	1 × B	0,50	1 × E
045.2E/14-ANW50	15,1	3,0	1,6	64,2	4860	14	32	56	35,0	35,0	3440	1200	4,64	1 × B	0,51	1 × E
050.2D/14-ANS50	18,0	4,6	0,6	67,3	6650	19	38	56	35,0	35,0	3000	1300	4,30	1 × B	0,52	1 × I
050.2E/14-ANS50	21,6	5,7	0,4	84,1	6470	19	36	56	42,0	42,0	3750	1300	5,05	1 × B	0,53	1 × I
050.2F/14-ANS50	21,5	3,8	2,1	100,9	6300	18	34	56	35,0	35,0	4500	1950	6,45	1 × B	0,54	1 × I
071.2D/14-AND50	30,4	6,5	1,3	117,6	11760	32	57	55	42,0	42,0	6250	2700	8,95	1 × C	0,80	1 × G
071.2E/14-AND50	38,3	10,6	0,3	147,0	11230	32	56	55	54,0	54,0	7500	2700	10,20	1 × C	0,81	1 × G
071.2F/14-AND50	35,4	5,2	3,2	176,4	10790	31	54	55	42,0	42,0	8750	2700	11,45	1 × C	0,82	1 × G
080.2D/14-AND50	44,6	8,0	2,1	184,5	17970	39	68	63	54,0	54,0	9000	3450	12,45	1 × C	1,35	1 × G
080.2E/14-AND50	53,8	10,0	1,9	230,7	17280	38	66	63	54,0	54,0	12000	3450	15,45	2 × C	1,36	1 × G
080.2F/14-AND50	61,4	12,0	1,6	276,8	16720	37	64	63	64,0	64,0	13500	3450	16,95	2 × C	1,36	1 × G
040.2F/17-ANW50	8,7	1,8	1,4	28,8	3100	12	24	52	28,0	28,0	2700	1000	3,70	1 × B	0,22	1 × E
040.2H/17-ANW50	11,1	2,9	0,5	38,4	2930	11	23	52	35,0	35,0	3240	1000	4,24	1 × B	0,22	1 × E
045.2E/17-ANW50	12,5	3,0	0,8	37,7	5320	15	36	56	35,0	35,0	3440	1200	4,64	1 × B	0,49	1 × E
045.2F/17-ANW50	13,8	2,7	1,6	45,3	5190	14	35	56	35,0	35,0	4300	1800	6,10	1 × B	0,50	1 × E
045.2H/17-ANW50	17,2	3,6	1,3	60,4	4840	14	33	56	35,0	35,0	6020	1800	7,82	1 × B	0,51	1 × E
050.2F/17-ANS50	18,0	3,8	1,3	59,4	6700	20	38	56	35,0	35,0	4500	1950	6,45	1 × B	0,51	1 × I
050.2H/17-ANS50	22,2	4,5	1,5	79,1	6420	19	36	56	42,0	42,0	6750	1950	8,70	1 × B	0,53	1 × I
071.2E/17-AND50	25,8	4,3	2,4	86,5	12200	32	58	55	42,0	42,0	7500	2700	10,20	1 × C	0,78	1 × G
071.2F/17-AND50	34,8	9,7	0,3	103,8	11890	32	57	55	54,0	54,0	8750	2700	11,45	1 × C	0,80	1 × G
071.2H/17-AND50	39,8	8,3	1,3	138,4	11190	32	54	55	54,0	54,0	11250	2700	13,95	1 × C	0,81	1 × G
080.2E/17-AND50	44,1	10,0	1,0	135,7	18520	40	69	63	54,0	54,0	12000	3450	15,45	2 × C	1,33	1 × G
080.2F/17-AND50	51,8	12,0	0,9	162,8	18170	39	68	63	64,0	64,0	13500	3450	16,95	2 × C	1,34	1 × G
080.2H/17-AND50	58,8	10,3	2,2	217,1	17210	38	66	63	64,0	64,0	18000	3450	21,45	2 × C	1,36	1 × G
040.2F/110-ANW50	7,4	1,8	0,7	20,8	3210	13	25	52	28,0	28,0	2700	1000	3,70	1 × B	0,21	1 × E
040.2H/110-ANW50	8,5	1,5	2,0	27,7	3060	12	24	52	28,0	28,0	3240	1000	4,24	1 × B	0,22	1 × E
045.2E/110-ANW50	9,1	1,6	2,2	27,2	5530	15	37	56	28,0	28,0	3440	1200	4,64	1 × B	0,48	1 × E
045.2F/110-ANW50	11,7	2,7	0,9	32,6	5400	15	36	56	35,0	35,0	4300	1800	6,10	1 × B	0,49	1 × E
045.2H/110-ANW50	13,5	2,3	2,3	43,5	5070	14	34	56	35,0	35,0	6020	1800	7,82	1 × B	0,50	1 × E
050.2H/110-ANS50	17,8	3,2	2,1	57,0	6620	20	39	56	35,0	35,0	6750	1950	8,70	1 × B	0,52	1 × I
071.2E/110-AND50	21,6	4,3	1,5	62,3	12550	33	59	55	42,0	42,0	7500	2700	10,20	1 × C	0,77	1 × G
071.2F/110-AND50	25,7	5,2	1,5	74,8	12330	33	58	55	42,0	42,0	8750	2700	11,45	1 × C	0,78	1 × G
071.2H/110-AND50	32,9	7,0	1,3	99,7	11720	32	56	55	54,0	54,0	11250	2700	13,95	1 × C	0,80	1 × G
080.2F/110-AND50	37,6	6,4	2,3	117,3	18660	40	70	63	54,0	54,0	13500	3450	16,95	2 × C	1,33	1 × G
080.2H/110-AND50	50,6	10,3	1,5	156,4	17970	39	68	63	64,0	64,0	18000	3450	21,45	2 × C	1,35	1 × G
040.2F/112-ANW50	6,8	1,8	0,4	17,6	3300	14	24	52	28,0	28,0	2700	1000	3,70	1 × B	0,21	1 × E
040.2H/112-ANW50	7,9	1,5	1,7	23,5	3140	13	24	52	28,0	28,0	3240	1000	4,24	1 × B	0,21	1 × E
045.2E/112-ANW50	8,4	1,6	1,8	23,1	5650	16	37	56	28,0	28,0	3440	1200	4,64	1 × B	0,48	1 × E
045.2F/112-ANW50	10,8	2,7	0,6	27,7	5550	15	37	56	35,0	35,0	4300	1800	6,10	1 × B	0,48	1 × E
045.2H/112-ANW50	12,6	2,3	2,0	37,0	5260	15	35	56	35,0	35,0	6020	1800	7,82	1 × B	0,49	1 × E
050.2H/112-ANS50	16,5	3,2	1,8	48,4	6750	20	40	56	35,0	35,0	6750	1950	8,70	1 × B	0,51	1 × I
071.2E/112-AND50	19,8	4,3	1,1	52,9	12770	33	60	55	42,0	42,0	7500	2700	10,20	1 × C	0,76	1 × G
071.2F/112-AND50	23,5	5,2	1,1	63,5	12600	33	59	55	42,0	42,0	8750	2700	11,45	1 × C	0,77	1 × G
071.2H/112-AND50	27,5	4,5	2,6	84,7	12070	32	57	55	42,0	42,0	11250	2700	13,95	1 × C	0,79	1 × G
080.2F/112-AND50	34,5	6,4	1,9	99,6	19000	40	70	63	54,0	54,0	13500	3450	16,95	2 × C	1,32	1 × G
080.2H/112-AND50	46,8	10,3	1,1	132,9	18310	40	68	63	64,0	64,0	18000	3450	21,45	2 × C	1,33	1 × G

➤ Die Wurfweitenangabe stellt die Entfernung vom Gerät dar, bei der isotherm in einem idealen Raum noch eine Luftgeschwindigkeit von 0,5 m/s messbar ist. Die Eindringtiefe des Luftstroms in den Kühlraum ist von den örtlichen Gegebenheiten (Raumgeometrie, Einbauten, Luftabkühlung, Platzierung und Bereifung der Geräte, Beladung des Kühlraums) abhängig.

➤ The indicated air throw represents the distance from the unit to a point where an air velocity of 0.5 m/s can still be measured isothermally in an ideal space. The penetration depth of the air flow in the cold room depends on the surrounding conditions (spatial geometry, installed equipment, air cooling, positioning of units and frost formation, load in cold room).

Gewicht und Maße

Weights and Dimensions

GGHN - 1 Ventilator - 1 Fan													Ablauf G-Gewinde flach- dichtend Drain G-thread flat sealing DIN-ISO 228-1 K
Typ Type	Rohrvolumen Tube volume	Nettogewicht Net weight	Abmessungen Dimensions										
			L	B	H	E	F	C	M	S	A		
	l	kg	mm	mm	mm	mm	mm	mm	mm	mm	mm	mm	
040.2D/14-ANW50	6,0	42	1090	540	550	680	425	210	870	580	400	G1¼"	
040.2F/14-ANW50	9,0	57	1090	815	560	680	700	210	870	855	400	G1¼"	
045.2D/14-ANW50	8,9	55	1360	665	650	890	545	240	970	700	500	G1¼"	
045.2E/14-ANW50	11,1	67	1360	665	650	890	545	240	970	700	500	G1¼"	
050.2D/14-ANS50	11,5	73	1470	645	750	1000	545	240	1070	700	550	G1¼"	
050.2E/14-ANS50	14,3	82	1470	645	750	1000	545	240	1070	700	550	G1¼"	
050.2F/14-ANS50	17,2	96	1470	825	760	1000	700	240	1070	855	550	G1¼"	
071.2D/14-AND50	19,1	192	2100	900	955	1360	715	380	1350	885	700	G2"	
071.2E/14-AND50	23,9	208	2100	900	955	1360	715	380	1350	885	700	G2"	
071.2F/14-AND50	28,7	236	2100	1050	965	1360	865	380	1350	1040	700	G2"	
080.2D/14-AND50	29,4	254	2340	910	1250	1600	715	380	1650	890	700	G2"	
080.2E/14-AND50	36,8	278	2340	910	1250	1600	715	380	1650	890	700	G2"	
080.2F/14-AND50	44,1	345	2340	1060	1260	1600	865	380	1650	1040	700	G2"	
040.2F/17-ANW50	9,0	52	1090	815	560	680	700	210	870	855	400	G1¼"	
040.2H/17-ANW50	12,0	57	1090	815	560	680	700	210	870	855	400	G1¼"	
045.2E/17-ANW50	11,1	60	1360	625	650	890	545	240	970	700	500	G1¼"	
045.2F/17-ANW50	13,4	70	1360	815	660	890	700	240	970	850	500	G1¼"	
045.2H/17-ANW50	17,8	78	1360	815	660	890	700	240	970	850	500	G1¼"	
050.2F/17-ANS50	17,2	81	1470	825	760	1000	700	240	1070	855	550	G1¼"	
050.2H/17-ANS50	22,9	96	1470	825	760	1000	700	240	1070	855	550	G1¼"	
071.2E/17-AND50	23,9	177	2100	900	955	1360	715	380	1350	885	700	G2"	
071.2F/17-AND50	28,7	220	2100	1050	965	1360	865	380	1350	1040	700	G2"	
071.2H/17-AND50	38,2	235	2100	1050	965	1360	865	380	1350	1040	700	G2"	
080.2E/17-AND50	36,8	255	2340	910	1250	1600	715	380	1650	890	700	G2"	
080.2F/17-AND50	44,1	291	2340	1060	1260	1600	865	380	1650	1040	700	G2"	
080.2H/17-AND50	58,8	320	2340	1060	1260	1600	865	380	1650	1040	700	G2"	
040.2F/110-ANW50	9,0	50	1090	815	560	680	700	210	870	855	400	G1¼"	
040.2H/110-ANW50	11,7	57	1090	815	560	680	700	210	870	855	400	G1¼"	
045.2E/110-ANW50	11,1	58	1360	665	650	890	545	240	970	700	500	G1¼"	
045.2F/110-ANW50	13,4	67	1360	815	660	890	700	240	970	850	500	G1¼"	
045.2H/110-ANW50	17,8	77	1360	815	660	890	700	240	970	850	500	G1¼"	
050.2H/110-ANS50	22,9	96	1470	825	760	1000	700	240	1070	855	550	G1¼"	
071.2E/110-AND50	23,9	188	2100	900	955	1360	715	380	1350	885	700	G2"	
071.2F/110-AND50	28,7	212	2100	1050	965	1360	865	380	1350	1040	700	G2"	
071.2H/110-AND50	38,2	235	2100	1050	965	1360	865	380	1350	1040	700	G2"	
080.2F/110-AND50	44,1	280	2340	1060	1260	1600	865	380	1650	1040	700	G2"	
080.2H/110-AND50	58,8	320	2340	1060	1260	1600	865	380	1650	1040	700	G2"	
040.2F/112-ANW50	9,0	49	1090	815	560	680	700	210	870	855	400	G1¼"	
040.2H/112-ANW50	11,7	55	1090	815	560	680	700	210	870	855	400	G1¼"	
045.2E/112-ANW50	11,1	56	1360	665	650	890	545	240	970	700	500	G1¼"	
045.2F/112-ANW50	13,4	65	1360	815	660	890	700	240	970	850	500	G1¼"	
045.2H/112-ANW50	17,8	75	1360	815	660	890	700	240	970	850	500	G1¼"	
050.2H/112-ANS50	22,9	92	1470	825	760	1000	700	240	1070	855	550	G1¼"	
071.2E/112-AND50	23,9	183	2100	900	955	1360	715	380	1350	885	700	G2"	
071.2F/112-AND50	28,7	209	2100	1050	965	1360	865	380	1350	1040	700	G2"	
071.2H/112-AND50	38,2	231	2100	1050	965	1360	865	380	1350	1040	700	G2"	
080.2F/112-AND50	44,1	275	2340	1060	1260	1600	865	380	1650	1040	700	G2"	
080.2H/112-AND50	58,8	314	2340	1060	1260	1600	865	380	1650	1040	700	G2"	

Wandkonsolen für Typen 040.2, 045.2, 050.2
Wall brackets for types 040.2, 045.2, 050.2

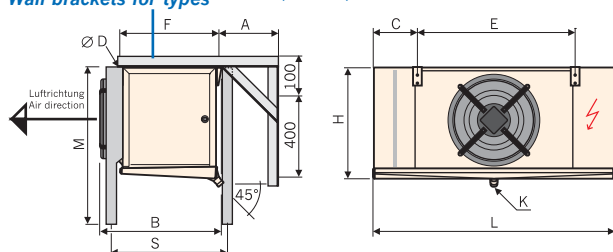

Deckenaufhänger
Ceiling hangers

Baugröße / Size
040 - 050 071 - 080

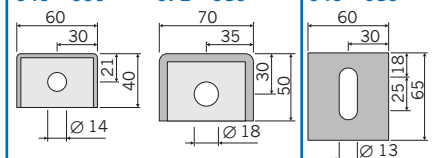

Fußplatte
Base plate

040 - 080

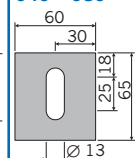

Technische Änderungen vorbehalten. Subject to technical amendments without prior notice!

GGHN - 2 Ventilatoren - 2 Fans

Typ Type	$t_i = -3\text{ °C}; dp = 0.8\text{ bar};$ Glykol 25%; $t_{i,1} = 10\text{ °C}$ bei 85% r. F. glycol 25%; $t_{i,1} = 10\text{ °C}$ at 85% relative humidity									Anschlüsse Connections		El. Abtauheizung El. defrost				
	Leistung Capacity	Volumenstrom Volume flow rate	Soleaustritt Brine outlet	Fläche Surface	Luftvolumenstrom Air volume flow	Wurfweite ohne Streamer Air throw without Streamer	Wurfweite mit Streamer Air throw with Streamer	Schalldruck Sound pressure	Ein Inlet	Aus Outlet	Block Coil	Tropfwanne Drip tray	Gesamt Total	Anschlussschema Connection diagram	P_{el} total	Anschlussklemmen optionale Ventilatorverkabelung connection terminals optional fan wiring
	kW	m ³ /h	°C	m ²	m ³ /h	m	m	dB(A)/3m	mm Ø	mm Ø	W	W	kW	1 × A	kW	1 × E
040.2D/24-ANW50	17,4	4,7	0,3	65,4	6120	12	27	55	35,0	35,0	3750	1200	4,95	1 × A	0,43	1 × E
040.2F/24-ANW50	18,2	2,5	3,7	98,0	5620	11	26	55	35,0	35,0	6250	1700	7,95	1 × B	0,44	1 × E
045.2D/24-ANW50	23,8	3,8	2,7	102,6	10220	17	36	59	35,0	35,0	4500	2300	6,80	1 × B	0,99	1 × E
045.2E/24-ANW50	30,7	6,3	1,4	128,3	9720	16	35	59	42,0	42,0	6000	2300	8,30	1 × B	1,01	1 × E
050.2D/24-ANS50	29,6	5,0	2,4	134,5	13300	21	41	59	42,0	42,0	7000	2400	9,40	1 × B	1,03	1 × I
050.2E/24-ANS50	38,8	6,9	2,1	168,2	12940	21	39	59	54,0	54,0	8750	2400	11,15	1 × B	1,05	1 × I
050.2F/24-ANS50	43,5	7,9	2,0	201,8	12600	20	37	59	54,0	54,0	10500	3600	14,10	1 × B	1,07	1 × I
071.2D/24-AND50	54,5	8,6	2,7	235,3	23520	35	64	57	54,0	54,0	12500	4500	17,00	2 × C	1,59	2 × G
071.2E/24-AND50	64,7	10,6	2,6	294,1	22460	35	63	57	54,0	54,0	15000	4500	19,50	2 × C	1,61	2 × G
071.2F/24-AND50	73,9	12,5	2,4	352,9	21580	34	61	57	64,0	64,0	17500	4500	22,00	2 × C	1,64	2 × G
080.2D/24-AND50	90,1	16,5	2,0	369,0	35940	43	75	66	64,0	64,0	18000	6000	24,00	2 × C	2,69	2 × G
080.2E/24-AND50	108,5	20,6	1,8	461,3	34560	42	73	66	76,1	76,1	24000	6000	30,00	3 × C	2,71	2 × G
080.2F/24-AND50	123,1	24,7	1,5	553,6	33440	41	71	66	88,9	88,9	27000	6000	33,00	3 × C	2,72	2 × G
040.2F/27-ANW50	15,7	2,5	2,8	57,7	6200	13	27	55	35,0	35,0	6250	1700	7,95	1 × B	0,43	1 × E
040.2H/27-ANW50	21,5	4,6	1,2	76,9	5860	12	26	55	42,0	42,0	7500	1700	9,20	1 × B	0,43	1 × E
045.2E/27-ANW50	23,9	4,8	1,6	75,5	10640	17	39	59	42,0	42,0	6000	2300	8,30	1 × B	0,98	1 × E
045.2F/27-ANW50	28,0	5,7	1,5	90,6	10380	16	38	59	42,0	42,0	7500	3450	10,95	1 × B	0,99	1 × E
045.2H/27-ANW50	34,9	7,6	1,2	120,8	9680	16	36	59	54,0	54,0	10500	3450	13,95	1 × B	1,01	1 × E
050.2F/27-ANS50	35,1	6,3	2,1	118,7	13400	22	41	59	54,0	54,0	10500	3600	14,10	1 × B	1,01	1 × I
050.2H/27-ANS50	41,6	6,6	2,7	158,3	12840	21	39	59	54,0	54,0	15750	3600	19,35	2 × B	1,05	1 × I
071.2E/27-AND50	49,7	7,7	2,9	173,0	24400	35	65	57	54,0	54,0	15000	4500	19,50	2 × C	1,56	2 × G
071.2F/27-AND50	53,1	6,9	3,9	207,6	23780	35	64	57	54,0	54,0	17500	4500	22,00	2 × C	1,59	2 × G
071.2H/27-AND50	80,3	17,3	1,2	276,8	22380	35	61	57	76,1	76,1	22500	4500	27,00	2 × C	1,61	2 × G
080.2E/27-AND50	79,8	13,3	2,5	271,3	37040	44	76	66	64,0	64,0	24000	6000	30,00	3 × C	2,66	2 × G
080.2F/27-AND50	94,0	15,9	2,4	325,6	36340	43	75	66	76,1	76,1	27000	6000	33,00	3 × C	2,68	2 × G
080.2H/27-AND50	118,6	21,2	2,1	434,2	34420	42	73	66	88,9	88,9	36000	6000	42,00	4 × C	2,71	2 × G
040.2F/210-ANW50	13,5	2,5	2,0	41,6	6420	14	28	55	35,0	35,0	6250	1700	7,95	1 × B	0,42	1 × E
040.2H/210-ANW50	17,3	3,3	1,8	55,4	6120	13	27	55	35,0	35,0	7500	1700	9,20	1 × B	0,43	1 × E
045.2E/210-ANW50	20,0	4,8	0,8	54,4	11060	17	40	59	42,0	42,0	6000	2300	8,30	1 × B	0,96	1 × E
045.2F/210-ANW50	23,7	5,7	0,8	65,3	10800	17	39	59	42,0	42,0	7500	3450	10,95	1 × B	0,98	1 × E
045.2H/210-ANW50	30,1	7,6	0,6	87,0	10140	16	37	59	54,0	54,0	10500	3450	13,95	1 × B	0,99	1 × E
050.2H/210-ANS50	36,0	6,6	1,9	114,1	13240	22	42	59	54,0	54,0	15750	3600	19,35	2 × B	1,03	1 × I
071.2E/210-AND50	41,9	7,7	2,0	124,7	25100	36	66	57	54,0	54,0	15000	4500	19,50	2 × C	1,54	2 × G
071.2F/210-AND50	46,0	6,9	3,0	149,6	24660	36	65	57	54,0	54,0	17500	4500	22,00	2 × C	1,56	2 × G
071.2H/210-AND50	59,4	9,3	2,8	199,5	23440	35	63	57	64,0	64,0	22500	4500	27,00	2 × C	1,59	2 × G
080.2F/210-AND50	79,5	15,9	1,5	234,7	37320	44	77	66	76,1	76,1	27000	6000	33,00	3 × C	2,66	2 × G
080.2H/210-AND50	102,2	21,2	1,4	312,9	35940	43	75	66	88,9	88,9	36000	6000	42,00	4 × C	2,69	2 × G
040.2F/212-ANW50	12,5	2,5	1,6	35,3	6600	15	27	55	35,0	35,0	6250	1700	7,95	1 × B	0,41	1 × E
040.2H/212-ANW50	17,3	4,6	0,4	47,1	6280	14	27	55	42,0	42,0	7500	1700	9,20	1 × B	0,42	1 × E
045.2E/212-ANW50	18,4	4,8	0,5	46,2	11300	18	40	59	42,0	42,0	6000	2300	8,30	1 × B	0,95	1 × E
045.2F/212-ANW50	21,8	5,7	0,5	55,4	11100	17	40	59	42,0	42,0	7500	3450	10,95	1 × B	0,96	1 × E
045.2H/212-ANW50	28,0	7,6	0,3	73,9	10520	17	38	59	54,0	54,0	10500	3450	13,95	1 × B	0,98	1 × E
050.2H/212-ANS50	33,5	6,6	1,6	96,9	13500	22	43	59	54,0	54,0	15750	3600	19,35	2 × B	1,01	1 × I
071.2E/212-AND50	38,5	7,7	1,6	105,9	25540	36	67	57	54,0	54,0	15000	4500	19,50	2 × C	1,52	2 × G
071.2F/212-AND50	42,7	6,9	2,6	127,0	25200	36	66	57	54,0	54,0	17500	4500	22,00	2 × C	1,54	2 × G
071.2H/212-AND50	55,5	9,3	2,4	169,4	24140	35	64	57	64,0	64,0	22500	4500	27,00	2 × C	1,58	2 × G
080.2F/212-AND50	72,3	15,9	1,1	199,3	38000	44	77	66	76,1	76,1	27000	6000	33,00	3 × C	2,64	2 × G
080.2H/212-AND50	94,1	21,2	1,0	265,7	36620	44	75	66	88,9	88,9	36000	6000	42,00	4 × C	2,66	2 × G

➤ Die Wurfweitenangabe stellt die Entfernung vom Gerät dar, bei der isotherm in einem idealen Raum noch eine Luftgeschwindigkeit von 0,5 m/s messbar ist. Die Eindringtiefe des Luftstroms in den Kühlraum ist von den örtlichen Gegebenheiten (Raumgeometrie, Einbauten, Luftabkühlung, Platzierung und Bereifung der Geräte, Beladung des Kühlraums) abhängig.

➤ The indicated air throw represents the distance from the unit to a point where an air velocity of 0.5 m/s can still be measured isothermally in an ideal space. The penetration depth of the air flow in the cold room depends on the surrounding conditions (spatial geometry, installed equipment, air cooling, positioning of units and frost formation, load in cold room).

GGHN - 2 Ventilatoren - 2 Fans													Ablauf G-Gewinde flach- dichtend Drain G-thread flat sealing DIN-ISO 228-1 K
Typ Type	Rohrvolumen Tube volume	Nettogewicht Net weight	Abmessungen Dimensions										
			L	B	H	E	F	C	M	S	A		
	l	kg	mm	mm	mm	mm	mm	mm	mm	mm	mm	mm	
040.2D/24-ANW50	10,6	75	1770	540	550	1360	425	210	870	580	400	G1¼"	
040.2F/24-ANW50	15,9	101	1770	815	560	1360	700	210	870	855	400	G1¼"	
045.2D/24-ANW50	16,2	97	2250	665	650	1780	545	240	970	700	500	G1¼"	
045.2E/24-ANW50	20,2	121	2250	665	650	1780	545	240	970	700	500	G1¼"	
050.2D/24-ANS50	21,0	131	2470	645	750	2000	545	240	1070	700	550	G1¼"	
050.2E/24-ANS50	24,7	150	2470	645	750	2000	545	240	1070	700	550	G1¼"	
050.2F/24-ANS50	31,4	184	2470	825	760	2000	700	240	1070	855	550	G1¼"	
071.2D/24-AND50	35,7	313	3460	900	955	2720	715	380	1350	885	700	G2"	
071.2E/24-AND50	44,7	342	3460	900	955	2720	715	380	1350	885	700	G2"	
071.2F/24-AND50	53,6	392	3460	1050	965	2720	865	380	1350	1040	700	G2"	
080.2D/24-AND50	55,5	424	3960	910	1250	3200	715	380	1650	890	700	G2"	
080.2E/24-AND50	69,3	470	3950	910	1250	3200	715	380	1650	890	700	G2"	
080.2F/24-AND50	83,2	580	3950	1060	1260	3200	865	380	1650	1040	700	G2"	
040.2F/27-ANW50	15,9	92	1770	815	560	1360	700	210	870	855	400	G1¼"	
040.2H/27-ANW50	21,2	100	1770	815	560	1360	700	210	870	855	400	G1¼"	
045.2E/27-ANW50	20,2	108	2250	665	650	1780	545	240	970	700	500	G1¼"	
045.2F/27-ANW50	24,3	125	2250	815	660	1780	700	240	970	850	500	G1¼"	
045.2H/27-ANW50	32,3	138	2250	815	660	1780	700	240	970	850	500	G1¼"	
050.2F/27-ANS50	29,9	154	2470	825	760	2000	700	240	1070	855	550	G1¼"	
050.2H/27-ANS50	41,9	184	2470	825	760	2000	700	240	1070	855	550	G1¼"	
071.2E/27-AND50	44,7	279	3460	900	955	2720	715	380	1350	885	700	G2"	
071.2F/27-AND50	53,6	357	3460	1050	965	2720	865	380	1350	1040	700	G2"	
071.2H/27-AND50	71,5	387	3460	1050	965	2720	865	380	1350	1040	700	G2"	
080.2E/27-AND50	69,3	425	3950	910	1250	3200	715	380	1650	890	700	G2"	
080.2F/27-AND50	83,2	483	3950	1060	1260	3200	865	380	1650	1040	700	G2"	
080.2H/27-AND50	111,0	531	3950	1060	1260	3200	865	380	1650	1040	700	G2"	
040.2F/210-ANW50	15,9	88	1770	815	560	1360	700	210	870	855	400	G1¼"	
040.2H/210-ANW50	21,2	100	1770	815	560	1360	700	210	870	855	400	G1¼"	
045.2E/210-ANW50	20,2	103	2250	665	650	1780	545	240	970	700	500	G1¼"	
045.2F/210-ANW50	24,3	117	2250	815	660	1780	700	240	970	850	500	G1¼"	
045.2H/210-ANW50	32,3	138	2250	815	660	1780	700	240	970	850	500	G1¼"	
050.2H/210-ANS50	41,9	185	2470	825	760	2000	700	240	1070	855	550	G1¼"	
071.2E/210-AND50	44,7	302	3460	900	955	2720	715	380	1350	885	700	G2"	
071.2F/210-AND50	53,6	341	3460	1050	965	2720	865	380	1350	1040	700	G2"	
071.2H/210-AND50	71,5	386	3460	1050	965	2720	865	380	1350	1040	700	G2"	
080.2F/210-AND50	83,2	461	3950	1060	1260	3200	865	380	1650	1040	700	G2"	
080.2H/210-AND50	111,0	531	3950	1060	1260	3200	865	380	1650	1040	700	G2"	
040.2F/212-ANW50	15,9	85	1770	815	560	1360	700	210	870	855	400	G1¼"	
040.2H/212-ANW50	21,2	96	1770	815	560	1360	700	210	870	855	400	G1¼"	
045.2E/212-ANW50	20,2	98	2250	665	650	1780	545	240	970	700	500	G1¼"	
045.2F/212-ANW50	24,3	114	2250	815	660	1780	700	240	970	850	500	G1¼"	
045.2H/212-ANW50	32,3	135	2250	815	660	1780	700	240	970	850	500	G1¼"	
050.2H/212-ANS50	41,9	176	2470	825	760	2000	700	240	1070	855	550	G1¼"	
071.2E/212-AND50	44,7	292	3460	900	955	2720	715	380	1350	885	700	G2"	
071.2F/212-AND50	53,6	334	3460	1050	965	2720	865	380	1350	1040	700	G2"	
071.2H/212-AND50	71,5	377	3460	1050	965	2720	865	380	1350	1040	700	G2"	
080.2F/212-AND50	83,2	451	3950	1060	1260	3200	865	380	1650	1040	700	G2"	
080.2H/212-AND50	111,0	518	3950	1060	1260	3200	865	380	1650	1040	700	G2"	

Wandkonsolen für Typen 040.2, 045.2, 050.2
Wall brackets for types 040.2, 045.2, 050.2

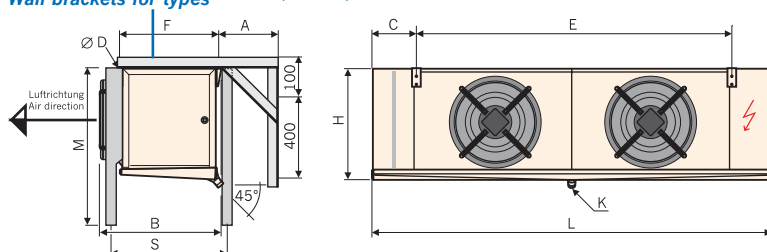

Deckenaufhänger
Ceiling hangers

Baugröße / Size
040 - 050 071 - 080

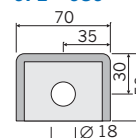
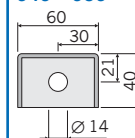

Fußplatte
Base plate

040 - 080

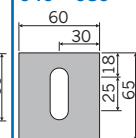

Technische Änderungen vorbehalten. Subject to technical amendments without prior notice!

GGHN - 3 Ventilatoren - 3 Fans

Typ Type	$t_i = -3\text{ °C}; dp = 0.8\text{ bar};$ Glykol 25%; $t_{i,1} = 10\text{ °C}$ bei 85% r. F. glycol 25%; $t_{i,1} = 10\text{ °C}$ at 85% relative humidity									Anschlüsse Connections			El. Abtauheizung El. defrost				
	Leistung Capacity	Volumenstrom Volume flow rate	Soleaustritt Brine outlet	Fläche Surface	Luftvolumenstrom Air volume flow	Wurfweite ohne Streamer Air throw without Streamer	Wurfweite mit Streamer Air throw with Streamer	Schalldruck Sound pressure	Ein Inlet	Aus Outlet	Block Coil	Tropfwanne Drip tray	Gesamt Total	Anschlussschema Connection diagram	P_{el} total	Anschlussklemmen optionale Ventilatorverkabelung connection terminals optional fan wiring	
	kW	m ³ /h	°C	m ²	m ³ /h	m	m	dB(A)/3m	mm Ø	mm Ø	W	W	kW	1 × B	kW	1 × E	
040.2D/34-ANW50	22,8	3,9	2,3	98,0	9180	13	29	57	35,0	35,0	4800	1800	6,60	1 × B	0,65	1 × E	
040.2F/34-ANW50	31,2	5,9	1,8	147,0	8430	12	28	57	42,0	42,0	8000	2400	10,40	1 × B	0,66	1 × E	
045.2D/34-ANW50	40,3	9,0	1,1	154,0	15330	18	38	60	54,0	54,0	6900	3000	9,90	1 × B	1,49	1 × E	
045.2E/34-ANW50	47,8	11,3	0,9	192,4	14580	17	37	60	54,0	54,0	9200	3000	12,20	1 × B	1,52	1 × E	
050.2D/34-ANS50	44,3	6,4	3,3	201,8	19950	22	43	60	54,0	54,0	9600	3200	12,80	1 × B	1,55	1 × I	
050.2E/34-ANS50	58,8	11,7	1,6	252,3	19410	22	41	60	54,0	54,0	12000	3200	15,20	1 × B	1,58	1 × I	
050.2F/34-ANS50	69,7	14,9	1,2	302,7	18900	21	39	60	64,0	64,0	14400	4800	19,20	2 × B	1,61	1 × I	
071.2D/34-AND50	92,2	20,3	1,1	352,9	35280	37	67	58	76,1	76,1	19000	6300	25,30	2 × C	2,39	3 × G	
071.2E/34-AND50	93,4	13,7	3,2	441,1	33690	37	66	58	64,0	64,0	22800	6300	29,10	3 × C	2,42	3 × G	
071.2F/34-AND50	107,9	16,4	3,0	529,3	32370	36	64	58	76,1	76,1	26600	6300	32,90	3 × C	2,46	3 × G	
080.2D/34-AND50	135,5	25,0	1,9	553,6	53910	45	78	67	88,9	88,9	27000	8700	35,70	3 × C	4,04	3 × G	
080.2E/34-AND50	133,8	16,8	4,2	692,0	51840	44	76	67	76,1	76,1	36000	8700	44,70	4 × C	4,07	3 × G	
080.2F/34-AND50	155,4	20,1	4,0	830,3	50160	43	74	67	88,9	88,9	40500	8700	49,20	4 × C	4,08	3 × G	
040.2F/37-ANW50	26,6	5,9	1,1	86,5	9300	14	29	57	42,0	42,0	8000	2400	10,40	1 × B	0,65	1 × E	
040.2H/37-ANW50	27,5	3,8	3,6	115,3	8790	13	28	57	42,0	42,0	9600	2400	12,00	1 × B	0,65	1 × E	
045.2E/37-ANW50	32,9	5,2	2,8	113,2	15960	18	41	60	42,0	42,0	9200	3000	12,20	1 × B	1,47	1 × E	
045.2F/37-ANW50	42,3	8,7	1,4	135,8	15570	17	40	60	54,0	54,0	11500	4500	16,00	2 × B	1,49	1 × E	
045.2H/37-ANW50	52,5	11,6	1,1	181,1	14520	17	38	60	64,0	64,0	16100	4500	20,60	2 × B	1,52	1 × E	
050.2F/37-ANS50	58,3	14,9	0,5	178,1	20100	23	43	60	64,0	64,0	14400	4800	19,20	2 × B	1,52	1 × I	
050.2H/37-ANS50	66,5	12,8	1,7	237,4	19260	22	41	60	64,0	64,0	21600	4800	26,40	2 × B	1,58	1 × I	
071.2E/37-AND50	78,5	13,7	2,2	259,5	36600	37	68	58	64,0	64,0	22800	6300	29,10	3 × C	2,34	3 × G	
071.2F/37-AND50	92,4	16,4	2,1	311,4	35670	37	67	58	76,1	76,1	26600	6300	32,90	3 × C	2,39	3 × G	
071.2H/37-AND50	115,6	21,9	1,8	415,2	33570	37	64	58	88,9	88,9	34200	6300	40,50	4 × C	2,42	3 × G	
080.2E/37-AND50	113,5	16,8	3,1	407,0	55560	46	79	67	76,1	76,1	36000	8700	44,70	4 × C	3,99	3 × G	
080.2F/37-AND50	134,1	20,1	3,0	488,4	54510	45	78	67	88,9	88,9	40500	8700	49,20	4 × C	4,02	3 × G	
080.2H/37-AND50	168,0	26,8	2,7	651,2	51630	44	76	67	88,9	88,9	54000	8700	62,70	5 × C	4,07	3 × G	
040.2F/310-ANW50	21,2	4,5	1,3	62,3	9630	15	30	57	42,0	42,0	8000	2400	10,40	1 × B	0,62	1 × E	
040.2H/310-ANW50	28,5	7,8	0,3	83,1	9180	14	29	57	54,0	54,0	9600	2400	12,00	1 × B	0,65	1 × E	
045.2E/310-ANW50	27,9	5,2	1,9	81,6	16590	18	42	60	42,0	42,0	9200	3000	12,20	1 × B	1,44	1 × E	
045.2F/310-ANW50	30,6	4,7	2,9	97,9	16200	18	41	60	42,0	42,0	11500	4500	16,00	2 × B	1,47	1 × E	
045.2H/310-ANW50	39,3	6,2	2,7	130,5	15210	17	39	60	54,0	54,0	16100	4500	20,60	2 × B	1,49	1 × E	
050.2H/310-ANS50	57,3	12,8	1,1	171,1	19860	23	44	60	64,0	64,0	21600	4800	26,40	2 × B	1,55	1 × I	
071.2E/310-AND50	65,6	13,7	1,3	187,0	37650	38	69	58	64,0	64,0	22800	6300	29,10	3 × C	2,31	3 × G	
071.2F/310-AND50	78,0	16,4	1,3	224,4	36990	38	68	58	76,1	76,1	26600	6300	32,90	3 × C	2,34	3 × G	
071.2H/310-AND50	99,9	21,9	1,1	299,2	35160	37	66	58	88,9	88,9	34200	6300	40,50	4 × C	2,39	3 × G	
080.2F/310-AND50	114,4	20,1	2,1	352,0	55980	46	80	67	88,9	88,9	40500	8700	49,20	4 × C	3,99	3 × G	
080.2H/310-AND50	147,1	26,8	2,0	469,3	53910	45	78	67	88,9	88,9	54000	8700	62,70	5 × C	4,04	3 × G	
040.2F/312-ANW50	19,6	4,5	1,0	52,9	9900	16	29	57	42,0	42,0	8000	2400	10,40	1 × B	0,62	1 × E	
040.2H/312-ANW50	22,8	3,8	2,4	70,6	9420	15	29	57	42,0	42,0	9600	2400	12,00	1 × B	0,63	1 × E	
045.2E/312-ANW50	25,7	5,2	1,5	69,3	16950	19	42	60	42,0	42,0	9200	3000	12,20	1 × B	1,43	1 × E	
045.2F/312-ANW50	28,5	4,7	2,5	83,1	16650	18	42	60	42,0	42,0	11500	4500	16,00	2 × B	1,44	1 × E	
045.2H/312-ANW50	36,9	6,2	2,4	110,9	15780	18	40	60	54,0	54,0	16100	4500	20,60	2 × B	1,47	1 × E	
050.2H/312-ANS50	48,7	8,9	2,0	145,3	20250	23	45	60	54,0	54,0	21600	4800	26,40	2 × B	1,52	1 × I	
071.2E/312-AND50	47,6	6,2	3,9	158,8	38310	38	70	58	54,0	54,0	22800	6300	29,10	3 × C	2,28	3 × G	
071.2F/312-AND50	62,7	10,2	2,6	190,6	37800	38	69	58	64,0	64,0	26600	6300	32,90	3 × C	2,31	3 × G	
071.2H/312-AND50	83,6	14,1	2,4	254,1	36210	37	67	58	76,1	76,1	34200	6300	40,50	4 × C	2,37	3 × G	
080.2F/312-AND50	104,6	20,1	1,7	298,9	57000	46	80	67	88,9	88,9	40500	8700	49,20	4 × C	3,96	3 × G	
080.2H/312-AND50	135,8	26,8	1,6	398,6	54930	46	78	67	88,9	88,9	54000	8700	62,70	5 × C	3,99	3 × G	

➤ Die Wurfweitenangabe stellt die Entfernung vom Gerät dar, bei der isotherm in einem idealen Raum noch eine Luftgeschwindigkeit von 0,5 m/s messbar ist. Die Eindringtiefe des Luftstroms in den Kühlraum ist von den örtlichen Gegebenheiten (Raumgeometrie, Einbauten, Luftabkühlung, Platzierung und Bereifung der Geräte, Beladung des Kühlraums) abhängig.

➤ The indicated air throw represents the distance from the unit to a point where an air velocity of 0.5 m/s can still be measured isothermally in an ideal space. The penetration depth of the air flow in the cold room depends on the surrounding conditions (spatial geometry, installed equipment, air cooling, positioning of units and frost formation, load in cold room).

GGHN - 3 Ventilatoren - 3 Fans													Ablauf G-Gewinde flach- dichtend Drain G-thread flat sealing DIN-ISO 228-1 K
Typ Type	Rohrvolumen Tube volume	Nettogewicht Net weight	Abmessungen Dimensions										
			L	B	H	E	F	C	M	S	A		
	l	kg	mm	mm	mm	mm	mm	mm	mm	mm	mm	mm	
040.2D/34-ANW50	15,2	105	2550	540	550	680	425	260	870	580	400	G1¼"	
040.2F/34-ANW50	22,9	143	2550	815	560	680	700	260	870	855	400	G1¼"	
045.2D/34-ANW50	23,4	134	3240	665	650	890	545	290	970	700	500	G1¼"	
045.2E/34-ANW50	29,3	170	3240	665	650	890	545	290	970	700	500	G1¼"	
050.2D/34-ANS50	30,5	183	3570	645	750	1000	545	290	1070	700	550	G1¼"	
050.2E/34-ANS50	37,0	211	3570	645	750	1000	545	290	1070	700	550	G1¼"	
050.2F/34-ANS50	45,7	245	3570	825	760	1000	700	290	1070	855	550	G1¼"	
071.2D/34-AND50	52,4	435	4820	900	955	1360	715	380	1350	885	700	G2"	
071.2E/34-AND50	64,0	481	4820	900	955	1360	715	380	1350	885	700	G2"	
071.2F/34-AND50	78,5	546	4820	1050	965	1360	865	380	1350	1040	700	G2"	
080.2D/34-AND50	81,5	592	5550	910	1250	1600	715	380	1650	890	700	G2"	
080.2E/34-AND50	101,9	670	5550	910	1250	1600	715	380	1650	890	700	G2"	
080.2F/34-AND50	122,3	819	5550	1060	1260	1600	865	380	1650	1040	700	G2"	
040.2F/37-ANW50	22,9	128	2550	815	560	680	700	260	870	855	400	G1¼"	
040.2H/37-ANW50	30,5	140	2550	815	560	680	700	230	870	855	400	G1¼"	
045.2E/37-ANW50	29,3	150	3240	665	650	890	545	290	970	700	500	G1¼"	
045.2F/37-ANW50	35,1	173	3240	815	660	890	700	290	970	850	500	G1¼"	
045.2H/37-ANW50	46,8	193	3240	815	660	890	700	290	970	850	500	G1¼"	
050.2F/37-ANS50	45,7	200	3570	825	760	1000	700	290	1070	855	550	G1¼"	
050.2H/37-ANS50	58,7	243	3570	825	760	1000	700	290	1070	855	550	G1¼"	
071.2E/37-AND50	64,0	386	4820	900	955	1360	715	380	1350	885	700	G2"	
071.2F/37-AND50	78,5	495	4820	1050	965	1360	865	380	1350	1040	700	G2"	
071.2H/37-AND50	104,7	539	4820	1050	965	1360	865	380	1350	1040	700	G2"	
080.2E/37-AND50	101,9	592	5550	910	1250	1600	715	380	1650	890	700	G2"	
080.2F/37-AND50	122,3	675	5550	1060	1260	1600	865	380	1650	1040	700	G2"	
080.2H/37-AND50	163,1	751	5550	1060	1260	1600	865	380	1650	1040	700	G2"	
040.2F/310-ANW50	22,9	121	2550	815	560	680	700	260	870	855	400	G1¼"	
040.2H/310-ANW50	30,5	141	2550	815	560	680	700	230	870	855	400	G1¼"	
045.2E/310-ANW50	29,3	142	3240	665	650	890	545	290	970	700	500	G1¼"	
045.2F/310-ANW50	35,1	162	3240	815	660	890	700	290	970	850	500	G1¼"	
045.2H/310-ANW50	46,8	192	3240	815	660	890	700	290	970	850	500	G1¼"	
050.2H/310-ANS50	60,9	252	3570	825	760	1000	700	290	1070	855	550	G1¼"	
071.2E/310-AND50	65,4	418	4820	900	955	1360	715	380	1350	885	700	G2"	
071.2F/310-AND50	78,5	470	4820	1050	965	1360	865	380	1350	1040	700	G2"	
071.2H/310-AND50	104,7	540	4820	1050	965	1360	865	380	1350	1040	700	G2"	
080.2F/310-AND50	122,3	642	5550	1060	1260	1600	865	380	1650	1040	700	G2"	
080.2H/310-AND50	163,1	751	5550	1060	1260	1600	865	380	1650	1040	700	G2"	
040.2F/312-ANW50	22,9	117	2550	815	560	680	700	260	870	855	400	G1¼"	
040.2H/312-ANW50	30,5	135	2550	815	560	680	700	230	870	855	400	G1¼"	
045.2E/312-ANW50	29,3	135	3240	665	650	890	545	290	970	700	500	G1¼"	
045.2F/312-ANW50	35,1	158	3240	815	660	890	700	290	970	850	500	G1¼"	
045.2H/312-ANW50	46,8	187	3240	815	660	890	700	290	970	850	500	G1¼"	
050.2H/312-ANS50	60,9	230	3570	825	760	1000	700	290	1070	855	550	G1¼"	
071.2E/312-AND50	65,4	403	4820	900	955	1360	715	380	1350	885	700	G2"	
071.2F/312-AND50	78,5	460	4820	1050	965	1360	865	380	1350	1040	700	G2"	
071.2H/312-AND50	104,7	525	4820	1050	965	1360	865	380	1350	1040	700	G2"	
080.2F/312-AND50	122,3	627	5550	1060	1260	1600	865	380	1650	1040	700	G2"	
080.2H/312-AND50	163,1	731	5550	1060	1260	1600	865	380	1650	1040	700	G2"	

Wandkonsolen für Typen 040.2, 045.2, 050.2 Wall brackets for types 040.2, 045.2, 050.2

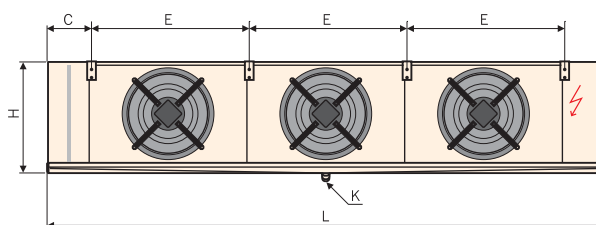
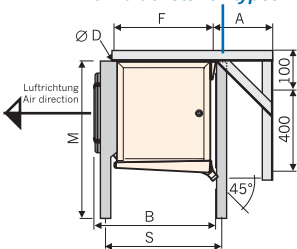

Deckenaufhänger Ceiling hangers

Baugröße / Size
040 - 050 071 - 080

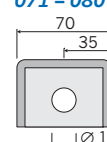
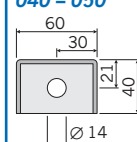

Fußplatte Base plate

040 - 080

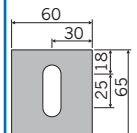

GGHN - 4 Ventilatoren - 4 Fans

Typ Type	$t_i = -3\text{ °C}; dp = 0.8\text{ bar};$ Glykol 25%; $t_{i,1} = 10\text{ °C}$ bei 85% r. F. glycol 25%; $t_{i,1} = 10\text{ °C}$ at 85% relative humidity			Fläche Surface	Luftvolumenstrom Air volume flow	Wurfweite ohne Streamer Air throw without Streamer	Wurfweite mit Streamer Air throw with Streamer	Schalldruck Sound pressure	Anschlüsse Connections		El. Abtauheizung El. defrost			Anschlussschema Connection diagram	P_{el} total aufgenommene el. Lstg. power consumption	Anschlussklemmen optionale Ventilatorverkabelung connection terminals optional fan wiring
	Leistung Capacity	Volumenstrom Volume flow rate	Soleaustritt Brine outlet						Kälte-träger / Sole Coolant / Brine	Ein Inlet	Aus Outlet	Block Coil	Tropfwanne Drip tray			
	kW	m ³ /h	°C	m ²	m ³ /h	m	m	dB(A)/3m	mm Ø	mm Ø	W	W	kW	1 × B	kW	1 × E
040.2D/44-ANW50	29,7	4,8	2,6	130,7	12240	14	31	58	42,0	42,0	6900	2200	9,10	1 × B	0,86	1 × E
040.2F/44-ANW50	39,3	6,7	2,3	196,1	11240	13	30	58	54,0	54,0	11500	3000	14,50	1 × B	0,88	1 × E
045.2D/44-ANW50	48,0	7,8	2,6	205,3	20440	19	40	61	54,0	54,0	9300	3600	12,90	1 × B	1,98	1 × E
045.2E/44-ANW50	57,2	9,8	2,3	256,6	19440	18	39	61	54,0	54,0	12400	3600	16,00	2 × B	2,02	1 × E
050.2D/44-ANS50	57,8	8,3	3,3	269,1	26600	23	45	61	54,0	54,0	14000	3600	17,60	2 × B	2,06	1 × I
050.2E/44-ANS50	69,4	10,1	3,2	336,4	25880	23	43	61	54,0	54,0	17500	3600	21,10	2 × B	2,10	1 × I
050.2F/44-ANS50	83,5	12,9	2,9	403,6	25200	22	41	61	64,0	64,0	21000	5400	26,40	3 × B	2,14	1 × I
040.2F/47-ANW50	31,9	5,1	2,7	115,3	12400	15	31	58	42,0	42,0	11500	3000	14,50	1 × B	0,86	1 × E
040.2H/47-ANW50	40,0	6,8	2,3	153,8	11720	14	30	58	54,0	54,0	13800	3000	16,80	2 × B	0,87	1 × E
045.2E/47-ANW50	48,2	9,8	1,5	150,9	21280	19	43	61	54,0	54,0	12400	3600	16,00	2 × B	1,96	1 × E
045.2F/47-ANW50	56,5	11,7	1,4	181,1	20760	18	42	61	64,0	64,0	15500	5400	20,90	2 × B	1,98	1 × E
045.2H/47-ANW50	63,1	10,1	2,7	241,5	19360	18	40	61	64,0	64,0	21700	5400	27,10	3 × B	2,02	1 × E
050.2F/47-ANS50	70,6	12,9	2,0	237,4	26800	24	45	61	64,0	64,0	21000	5400	26,40	3 × B	2,02	1 × I
050.2H/47-ANS50	78,7	11,0	3,5	316,6	25680	23	43	61	64,0	64,0	31500	5400	36,90	4 × B	2,10	1 × I
040.2F/410-ANW50	27,4	5,1	1,9	83,1	12840	16	32	58	42,0	42,0	11500	3000	14,50	1 × B	0,83	1 × E
040.2H/410-ANW50	35,0	6,8	1,7	110,8	12240	15	31	58	54,0	54,0	13800	3000	16,80	2 × B	0,86	1 × E
045.2E/410-ANW50	32,5	4,5	3,6	108,8	22120	19	44	61	42,0	42,0	12400	3600	16,00	2 × B	1,92	1 × E
045.2F/410-ANW50	43,2	7,5	2,2	130,5	21600	19	43	61	54,0	54,0	15500	5400	20,90	2 × B	1,96	1 × E
045.2H/410-ANW50	55,1	10,1	2,0	174,0	20280	18	41	61	64,0	64,0	21700	5400	27,10	3 × B	1,98	1 × E
050.2H/410-ANS50	68,8	11,0	2,6	228,1	26480	24	46	61	64,0	64,0	31500	5400	36,90	4 × B	2,06	1 × I
040.2F/412-ANW50	25,3	5,1	1,5	70,6	13200	17	31	58	42,0	42,0	11500	3000	14,50	1 × B	0,82	1 × E
040.2H/412-ANW50	32,7	6,8	1,3	94,1	12560	16	31	58	54,0	54,0	13800	3000	16,80	2 × B	0,84	1 × E
045.2E/412-ANW50	30,3	4,5	3,2	92,4	22600	20	44	61	42,0	42,0	12400	3600	16,00	2 × B	1,90	1 × E
045.2F/412-ANW50	40,0	7,5	1,8	110,9	22200	19	44	61	54,0	54,0	15500	5400	20,90	2 × B	1,92	1 × E
045.2H/412-ANW50	51,6	10,1	1,7	147,8	21040	19	42	61	64,0	64,0	21700	5400	27,10	3 × B	1,96	1 × E
050.2H/412-ANS50	64,2	11,0	2,3	193,8	27000	24	47	61	64,0	64,0	31500	5400	36,90	4 × B	2,02	1 × I

➤ Die Wurfweitenangabe stellt die Entfernung vom Gerät dar, bei der isotherm in einem idealen Raum noch eine Luftgeschwindigkeit von 0,5 m/s messbar ist. Die Eindringtiefe des Luftstroms in den Kühlraum ist von den örtlichen Gegebenheiten (Raumgeometrie, Einbauten, Luftabkühlung, Platzierung und Bereifung der Geräte, Beladung des Kühlraums) abhängig.

➤ The indicated air throw represents the distance from the unit to a point where an air velocity of 0.5 m/s can still be measured isothermally in an ideal space. The penetration depth of the air flow in the cold room depends on the surrounding conditions (spatial geometry, installed equipment, air cooling, positioning of units and frost formation, load in cold room).

GGHN - 4 Ventilatoren - 4 Fans												
Typ Type	Rohrvolumen Tube volume	Nettogewicht Net weight	Abmessungen Dimensions									Ablauf G-Gewinde flach- dichtend Drain G-thread flat sealing DIN-ISO 228-1
			L	B	H	E	F	C	M	S	A	
	l	kg	mm	mm	mm	mm	mm	mm	mm	mm	mm	K
040.2D/44-ANW50	19,9	144	3230	540	550	680	425	260	870	580	400	G1¼"
040.2F/44-ANW50	29,8	189	3230	815	560	680	700	260	870	855	400	G1¼"
045.2D/44-ANW50	30,7	184	4130	665	650	890	545	290	970	700	500	G1¼"
045.2E/44-ANW50	38,3	231	4130	665	650	890	545	290	970	700	500	G1¼"
050.2D/44-ANS50	40,0	251	4570	645	750	1000	545	290	1070	700	550	G1¼"
050.2E/44-ANS50	48,5	288	4570	645	750	1000	545	290	1070	700	550	G1¼"
050.2F/44-ANS50	59,9	346	4570	825	760	1000	700	290	1070	855	550	G1¼"
040.2F/47-ANW50	29,8	170	3230	815	560	680	700	260	870	855	400	G1¼"
040.2H/47-ANW50	39,7	186	3230	815	560	680	700	230	870	855	400	G1¼"
045.2E/47-ANW50	38,3	206	4130	665	650	890	545	290	970	700	500	G1¼"
045.2F/47-ANW50	46,0	241	4130	815	660	890	700	290	970	850	500	G1¼"
045.2H/47-ANW50	61,3	267	4130	815	660	890	700	290	970	850	500	G1¼"
050.2F/47-ANS50	59,9	289	4570	825	760	1000	700	290	1070	855	550	G1¼"
050.2H/47-ANS50	79,9	344	4570	825	760	1000	700	290	1070	855	550	G1¼"
040.2F/410-ANW50	29,8	162	3230	815	560	680	700	260	870	855	400	G1¼"
040.2H/410-ANW50	39,7	187	3230	815	560	680	700	230	870	855	400	G1¼"
045.2E/410-ANW50	38,3	194	4130	665	650	890	545	290	970	700	500	G1¼"
045.2F/410-ANW50	46,0	201	4130	815	660	890	700	290	970	850	500	G1¼"
045.2H/410-ANW50	61,3	263	4130	815	660	890	700	290	970	850	500	G1¼"
050.2H/410-ANS50	79,9	346	4570	825	760	1000	700	290	1070	855	550	G1¼"
040.2F/412-ANW50	29,8	156	3230	815	560	680	700	260	870	855	400	G1¼"
040.2H/412-ANW50	39,7	178	3230	815	560	680	700	230	870	855	400	G1¼"
045.2E/412-ANW50	38,3	186	4130	665	650	890	545	290	970	700	500	G1¼"
045.2F/412-ANW50	46,0	217	4130	815	660	890	700	290	970	850	500	G1¼"
045.2H/412-ANW50	61,3	256	4130	815	660	890	700	290	970	850	500	G1¼"
050.2H/412-ANS50	79,9	329	4570	825	760	1000	700	290	1070	855	550	G1¼"

Wandkonsolen für Typen 040.2, 045.2, 050.2
Wall brackets for types 040.2, 045.2, 050.2

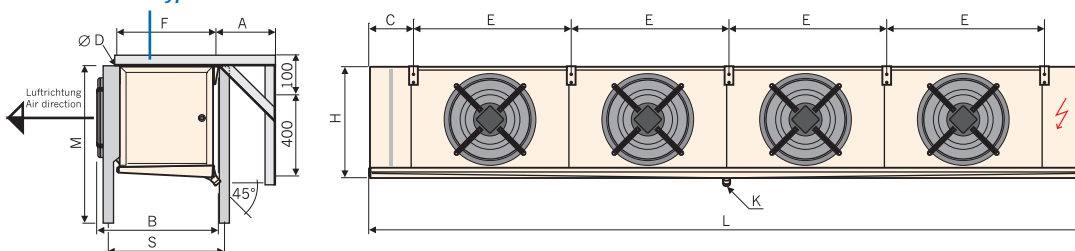

Deckenaufhänger
Ceiling hangers

Baugröße / Size
040 - 050

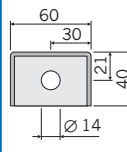

071 - 080

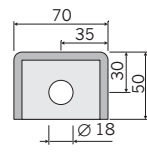

Fußplatte
Base plate

040 - 080

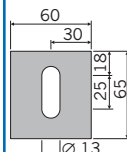

Daten je Ventilator

Nominal data per fan

Typ Type	Motordaten je Ventilator (Nennwerte) Motor data per fan (nominal values)					
	Ventilator Fan Ø	Anzahl Phase / Spannung / Frequenz Number of phases / voltage / frequency	Drehzahl Speed min ⁻¹	Typenschild- angaben Nameplate data W	Stromstärke Current A	Schalleistungspegel Sound power level dB(A)
040.2...	400	1/230/50	1390	225	1,05	74
045.2...	450	1/230/50	1360	475	2,2	78
050.2...	500	3/400/50	1410	620	1,45	78
071.2...	710	3/400/50	900	880	1,65	77
080.2...	800	3/400/50	890	1400	2,7	86

Anschlussschema

el. Abtauheizung und Ventilator

Connection diagram

electrical defrost and fan

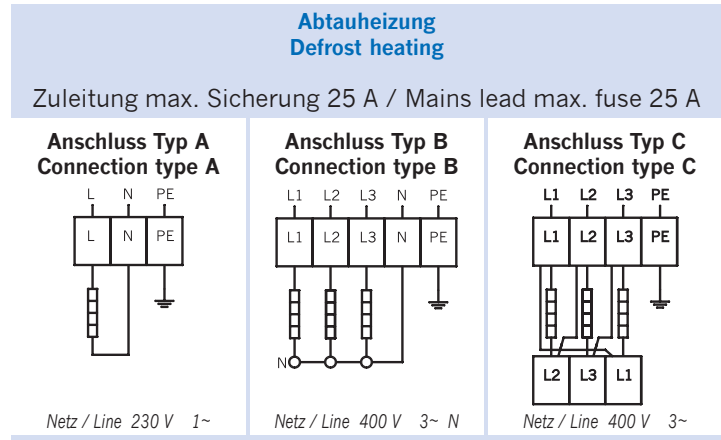

Ventilator (*Werkseitige Verkabelung optional) Fan (*optional: pre-wired at factory)

Anschluss Typ E Connection type E

Netz / Line
230 V 1~ 50 Hz

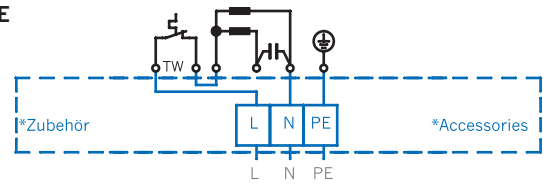

Anschluss Typ I Connection type I

Netz / Line
400 V 3~ 50 Hz
Thermokontakt intern
internal thermal contact

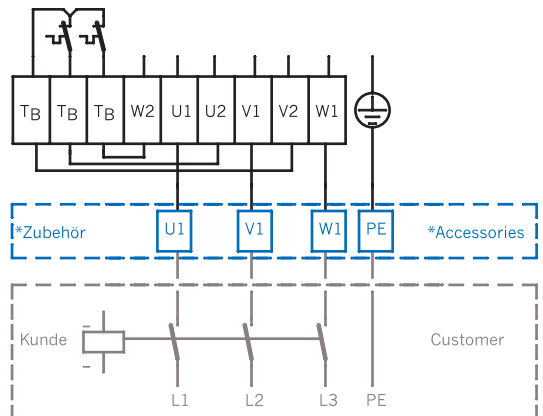

Anschluss Typ G Connection type G

Netz / Line
400 V 3~ 50 Hz
Thermokontakt extern
external thermal contact

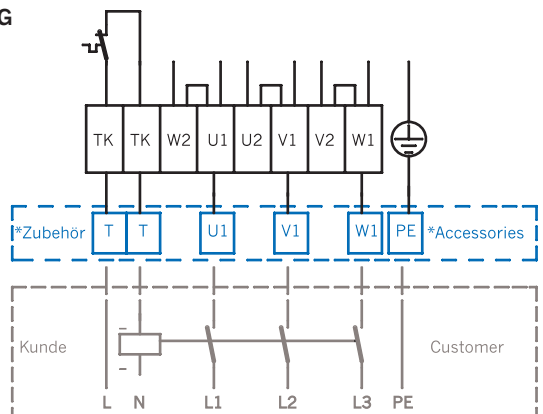

Anschlüsse

Connections

Ausführung der Anschlussstutzen Construction of connection piece							
Anschlussgröße Dimension of connection							
D	22	28	35	42	54	64	80
S	26,9	33,7	42,4	48,3	60,3	76,1	88,9
G	¾"	1"	1¼"	1½"	2"	2½"	–
DN	20	25	32	40	50	65	80

Stutzen "D" – Serienausführung, Lötanschluss Kupfer
Connection "D" – standard version, soldered joint copper

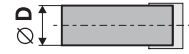

Stutzen "S" – mit St-Rohr nahtlos DIN 2948, Schweißanschluss Stahl
Connection "S" – with steel tube seamless DIN 2948, welded joint steel



Stutzen "G" – mit Gewinde-Übergangsnippel, Nr.: 4243 G, Rotguss
Connection "G" – with thread transition nipple, No.: 4243 G, red bronze

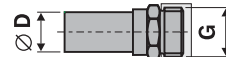

Stutzen "DN" – mit Flansch PN 16 Stahl DIN 2633 Rotguss DIN 2566
Connection "DN" – with flange PN 16 steel DIN 2633 red bronze DIN 2566

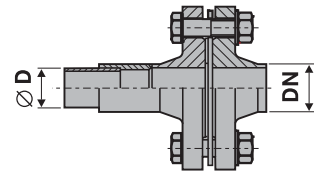

Güntner Product Calculator die bessere Wahl

Güntner Product Calculator the perfect choice

Für eine **genaue thermodynamische Auslegung** mit anderen Betriebsbedingungen (auch für andere Luftfeuchte, Epoxidharz-beschichtete Lamellen und anwendungsrelevante Kälteträger) empfehlen wir die Verwendung des **Güntner Product Calculator**.

We recommend that you use the **Güntner Product Calculator** for an **exact thermodynamic calculation** in different conditions (also for other air humidity, epoxy resin coated fins and application relevant cooling medium).



Kälteträger / Sole
Coolant / Brine

Luftfeuchte
Air humidity

Epoxidharz-
beschichtete
Lamellen
Epoxy resin
coated fins

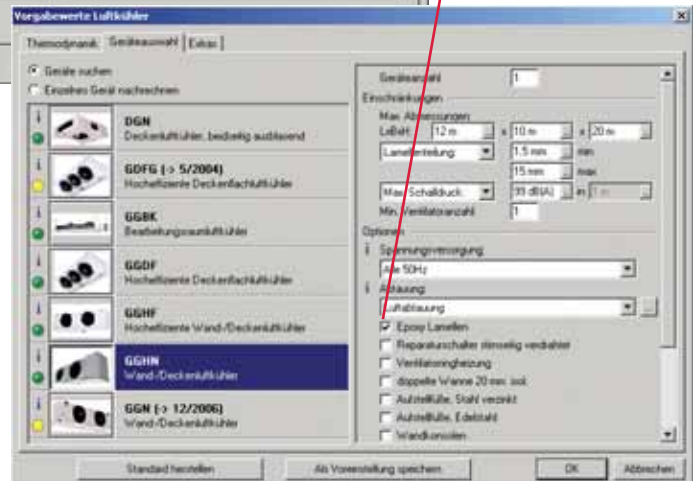

Kühlerblock Cooler coil

Lamellen aus Aluminium, Rohrteilung 50 × 50 mm fluchtend, Kupferrohre Ø 15 mm. Lamellenteilung 4, 7, 10 und 12 mm. Anschlüsse zur Entlüftung und Entleerung sind an der Anschlussseite innerhalb des Gehäuses vorhanden. Die kälteträgerführenden Kernrohre sind durch die bewährte Güntner Tragrohrkonstruktion entlastet. Dadurch ergibt sich eine erhöhte Sicherheit gegen Undichtigkeit.

Fins made of aluminium, tube pattern aligned 50 × 50 mm, copper tubes Ø 15 mm. Fin spacing 4, 7, 10 and 12 mm. Inside the casing on the connection side, connections for ventilation and drain are provided. The coolant-carrying core tubes are stressed less due to Güntner's proven floating coil design. This results in increased safety against leakage.

Gehäuse Casing

Baugröße 040 – 050: AlMg3, Pulverbeschichtet RAL 9003 (Signalweiß), Baugröße 071 – 080: Stahl verzinkt, Pulverbeschichtet RAL 9003 (Signalweiß), durch aufklappbare Seitenverkleidung einfacher Zugang zu den Anschlüssen.

Sizes 040 – 050: AlMg3, powder-coated, RAL 9003 (signal white), Sizes 071 – 080: galvanised steel, powder-coated RAL 9003 (signal white), connections are easily accessible due to hinged side covering.

Tropfwanne Drip tray

AlMg3, Pulverbeschichtet RAL 9003 (Signalweiß). Zur leichteren Reinigung ist die Tropfwanne abklapp- bzw. abnehmbar. Einwandfreier Tauwasserablauf durch optimal gestalteten Ablauf. Ablaufstutzen unter 45° montiert, mit G-Gewinde flachdichtend nach DIN-ISO 228-1.

AlMg3, powder-coated, RAL 9003 (signal white). For easy cleaning the drip tray can be folded down or removed. Perfect condensation water drain due to optimal drain design. Drain nozzle mounted at an angle below 45°, with G-thread flat sealing acc. to DIN-ISO 228-1.

Ventilatoren Fans

Geräuscharme Axialventilatoren mit wartungsfreien Motoren mit Schutzart IP54, ISO F und DIN VDE 0530, Wuchtgüte Q 6,3 n. VDI 2060, Schutzgitter gemäß EN 294. Drehstrom 400 V 3~ 50 Hz bzw. Wechselstrom 230 V 1~ 50 Hz, zulässige Lufttemperatur (Einsatzbereich) –30 °C bis +45 °C. Luftrichtung saugend. Wir behalten uns vor, verschiedene Ventilatorfabrikate einzusetzen. Je nach Ventilatorfabrikat können die Motordaten geringfügig abweichen. Die entsprechenden elektrischen Daten müssen dem Typenschild entnommen werden, elektrische Leistungsangaben gemäß EN 328. Die Stromaufnahme erhöht sich mit tiefer Umgebungstemperatur und höheren Gegendrücken.

Low-noise axial fans, with maintenance-free motors in protection class IP54, ISO F and DIN VDE 0530, balance quality Q 6.3 acc. to VDI 2060, protection guard acc. to EN 294. three-phase current 400 V 3~ 50 Hz or alternating current 230 V 1~ 50 Hz, admissible air temperature (operating range) –30 °C to +45 °C. We reserve the right to use fans of different manufacturers. Depending on the fan type, the motor data may slightly vary. For the corresponding electrical data, please refer to the nameplate, electrical capacity specifications acc. to EN 328. At low ambient temperatures and different air resistance the power consumption will increase.

<p>Schallangaben Sound specifications</p>	<p>Die Absicherung der Motoren muss über die eingebauten Thermo-kontakte (Öffner) erfolgen. Bei den Baugrößen 040 – 050 sind diese optional bereits intern ver-schaltet (s. Anschlussschema).</p>	<p>The built-in thermal contacts (thermistors) must be used as motor protection. For sizes 040 – 050, they are optionally already internally wired (see connection diagram).</p>
<p>Abtaung Defrosting</p>	<p>gegen Mehrpreis: • Elektrisch, nach VDE 0720 in Block und Wanne, Abtauleistung reduzierbar durch einfaches Umklemmen, Typenbezeichnung: GGHN..../...E</p>	<p>at additional charge: • Electrical defrosting acc. to VDE 0720 in coil and drip tray may be reduced through simple reconnection Type designation: GGHN..../...E</p>
<p>Leistungsangaben Capacity</p>	<p>Die Nennleistungen beziehen sich auf 25 Vol. % Glykol: Kälte-träger-Eintrittstemperatur $t_1 = -3 \text{ }^\circ\text{C}$ Kälte-träger-seitiger Druckverlust $d_p = 0,8 \text{ bar}$ Luft-eintrittstemperatur $t_{L1} = 10 \text{ }^\circ\text{C}$ bei 85 % r. F. Leistungen für abweichende Bedin-gungen sind auf Anfrage zu erhalten. Mit unserer Auslegungssoftware Güntner Product Calculator erhalten Sie eine genaue thermodynamische Auslegung der gewünschten Geräte-variante mit anderen Betriebs-parametern (auch für andere Luft-feuchte, Epoxidharz-beschichtete Lamellen und an-dwendungsrelevante Kälte-träger).</p>	<p>The nominal capacity refers to 25 % vol. glycol: Coolant inlet temperature $t_1 = -3 \text{ }^\circ\text{C}$ pressure loss on the part of coolant $d_p = 0.8 \text{ bar}$ Air inlet temperature $t_{L1} = 10 \text{ }^\circ\text{C}$ at 85 % relative humidity Capacities for non-standard conditions on request. We recommend that you use our software package Güntner Product Calculator for an exact thermodynamic design in different operating conditions (also for other air humidity values, epoxy resin coated fins and application relevant coolants).</p>
<p>Verpackung Packing</p>	<p>Die Geräte werden in Einbaulage verpackt mit montierter Wanne geliefert.</p>	<p>The units are delivered packaged in installation position with mounted drip tray.</p>

Anmerkung Notes

Die Geräte werden mit Aufhängern für Deckenbefestigung geliefert. Beim Einsatz der Kühler im Tief-temperaturbereich empfehlen wir elektrische Ringheizung für die Ventilatoren. Bei Betrieb der Geräte unter $t_o = -40$ °C wegen der speziellen Materialanforderung und -auswahl bitte Rücksprache mit dem Vertrieb halten. Alle elektrischen Teile sind entsprechend den EN-Normen ausgeführt. Andere Rohrwanddicken und Lamellenteilungen sind auf Anfrage lieferbar.

The units are supplied with brackets for ceiling mounting. In case of use of the coolers for low temperatures, we recommend electrical ring heaters for the fans. For unit operation below $t_o = -40$ °C please consult our sales department because of the special material requirement and selection. All electrical parts are in compliance with the EN-standards. Other tube wall thicknesses and fin spacings on request.

Zubehör Accessories

(gegen Mehrpreis lieferbar)

- Elektrische Abtaugung für Block und Wanne
- Elektrische Ventilator-Ringheizung
- Aufstellfüße
- Wandkonsolen (Typen 040.2, 045.2, 050.2)
- Güntner Streamer
- Anschluss für Luftverteilschlauch
- Abtauklappe
- Reparaturschalter für Ventilatoren
- Verkabelung der Ventilatoren auf gemeinsamen Klemmkasten

(available at additional charge)

- Electrical defrosting in coil and drip tray
- Electrical fan ring heaters
- Feet for floor mounting
- Wall brackets (Types 040.2, 045.2, 050.2)
- Güntner Streamer
- Connection for air distribution sock
- Defrost flap
- Isolator switch for fans
- Wiring of fans on conjoint terminal box

Zubehörteile verändern die Funktion des Gerätes.

Accessories change the function of the unit.

Optionen und Varianten Options and variants

- Isolierte Wanne
- Verstärkte Ventilatoren
- Gehäuse in Edelstahl
- Epoxidharz-beschichtete Aluminium-Lamellen
- Schwenkbare Ventilatereinheit
- Edelstahlrohre
- Flanschanschlüsse
- Gewindeanschlüsse
- Schweißstutzen

- Insulated drip tray
- Reinforced fans
- Casing made of stainless steel
- Epoxy coated aluminium fins
- Swiveling fans
- Tubes made of stainless steel
- Flange connections
- Thread connections
- Welded connections